

Type of Contact Points

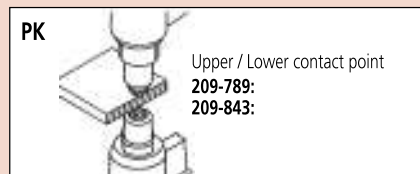
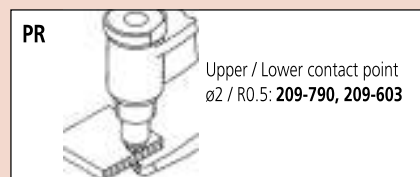
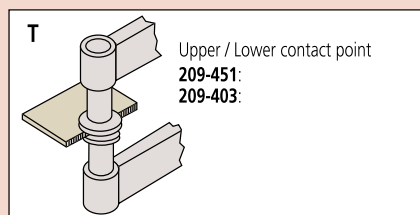
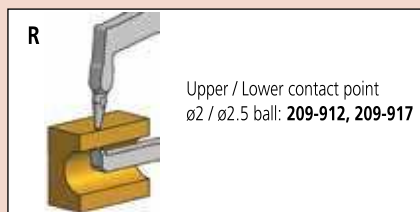
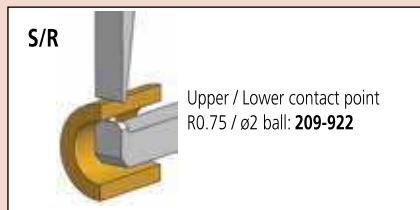
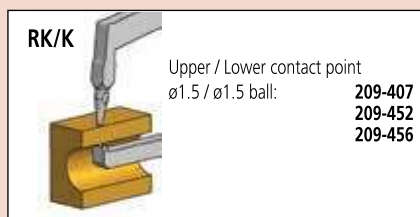
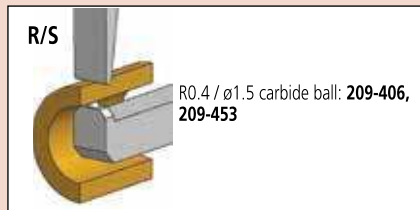
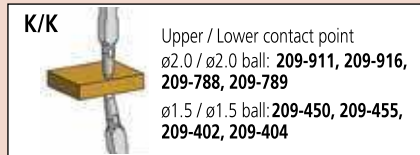
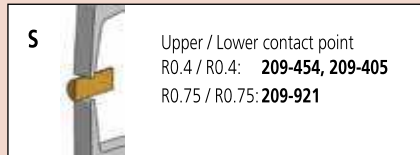

Dial Caliper Gages

SERIES 209 — External Measurement Type

IP65

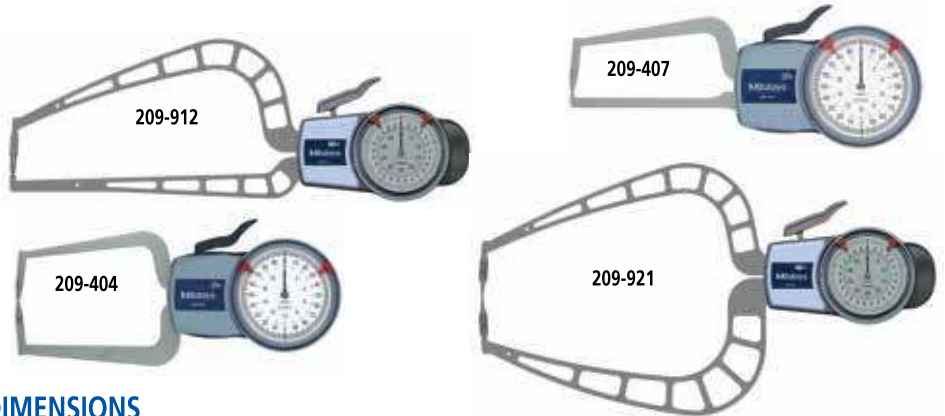

DIMENSIONS

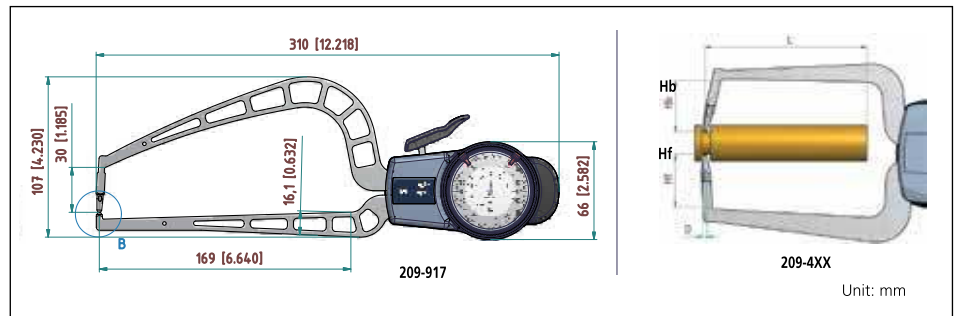

SPECIFICATIONS

Inch

Measuring Range	Order No.	Graduation	Accuracy	Max. Measuring Depth L	Length Hb	Length Hf	Measuring Contact Type	Size (mm)	Mass (g)
0 - .40"	209-450	.0002"	± .0008"	1.37"	.75"	.75"	K/K	ø1.5	170
0 - .40"	209-451	.0002"	± .001"	1.37"	.85"	.58"	T	ø6	175
0 - .40"	209-452	.0002"	± .0008"	1.37"	.75"	.035"	RK/K	ø1.5	165
0 - .40"	209-453	.0002"	± .0008"	1.37"	.75"	.035"	R/S	Chisel R0.4, ø1.5	165
0 - .50"	209-789	.005"	± .005"	1.38"	-	-	PK	ø2, Chisel R0.5	40
0 - .50"	209-790	.005"	± .005"	1.38"	-	-	PR	ø2	40
0 - .80"	209-454	.0005"	± .0015"	3.2"	.97"	.97"	S	Chisel R0.4	210
0 - .80"	209-455	.0005"	± .0015"	3.2"	.97"	.97"	K/K	ø1.5	210
0 - .80"	209-456	.0005"	± .0015"	3.2"	.97"	.10"	RK/K	ø1.5	200
0 - .80"	209-457	.0005"	± .0015"	3.2"	.97"	.10"	R/S	Chisel R0.4, ø1.5	200
0 - 2.0"	209-916	.001"	± .002"	6.6"	1.2"	1.2"	K/K	ø3	430
0 - 2.0"	209-917	.001"	± .002"	6.6"	1.2"	.18"	RK/K	ø3	400

Metric

Measuring Range	Order No.	Graduation	Accuracy	Max. Measuring Depth L	Length Hb	Length Hf	Measuring Contact	Size (mm)	Mass (g)
0 - 10mm	209-402	0.005mm	±0.015mm	35mm	19.1mm	18.6mm	K/K	ø1.5	240
0 - 10mm	209-403	0.005mm	±0.02mm	35mm	21.7mm	14.8mm	T	ø6	175
0 - 20mm	209-404	0.01mm	±0.03mm	85mm	7mm	24.6mm	K/K	ø1.5	210
0 - 20mm	209-405	0.01mm	±0.03mm	85mm	7mm	24.6mm	S	R 0.4	210
0 - 20mm	209-406	0.01mm	±0.03mm	80mm	7mm	2.5mm	R/S	Chisel R0.4, ø1.5	200
0 - 20mm	209-407	0.01mm	±0.03mm	80mm	7mm	2.5mm	RK/K	ø1.5	200
0 - 10mm	209-843	0.1mm	±0.1mm	36mm	-	-	PK	ø2, Chisel R0.5	40
0 - 10mm	209-603	0.1mm	±0.1mm	33mm	-	-	PR	ø2	40
0 - 50mm	209-911	0.05mm	±0.05mm	167mm	30mm	30mm	KK	Ball ø3mm	430
0 - 50mm	209-912	0.05mm	±0.05mm	169mm	30mm	4.5mm	RK/K	Ball ø3mm	400
0 - 50mm	209-921	0.05mm	±0.05mm	167mm	30mm	30mm	S	Chisel R0.75	490
0 - 50mm	209-922	0.05mm	±0.05mm	169mm	30mm	4.5mm	R/S	ø3, Chisel R0.75	400